

# Maintenance Oil & Gas

Contact : Mr. Lefèvre

The Armitec company is involved in the maintenance of loading arms for liquefied gas, essential equipment for the operation of LNG terminals.

Our work is part of the strategy to maintain the operation of our clients' installations.

Our action concerns, on the one hand, mechanical maintenance work on the wharves of a SEVESO 2 site, interventions subject to the particular requirements of work in an explosive atmosphere, but also in conditions of height and exposure to climatic hazards.

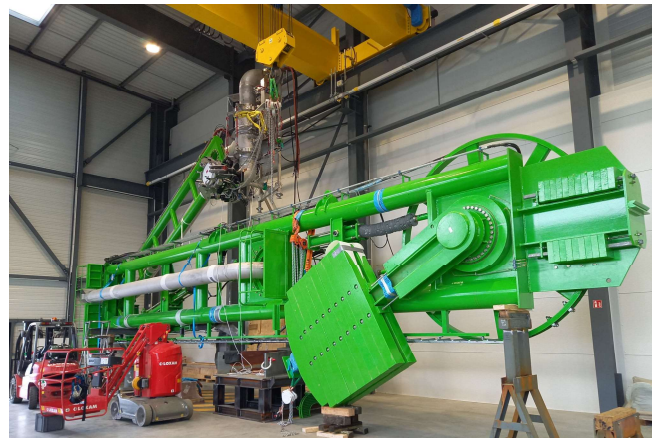

From the study, to the management of the project, including the design and manufacture of specific tools necessary for the service: we control the project in its entirety. One company, one contact for greater fluidity and responsiveness.

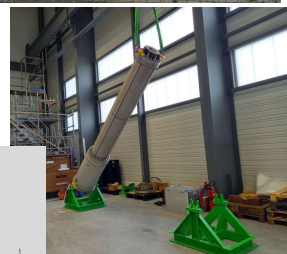
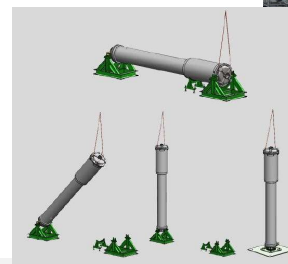
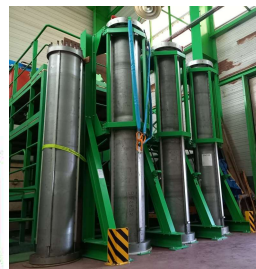
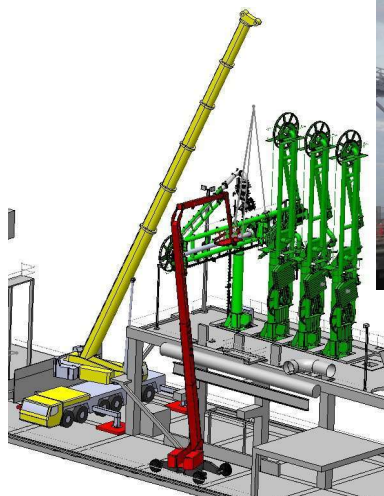
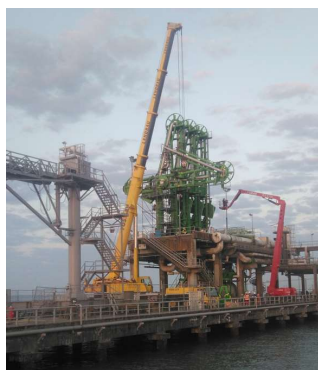
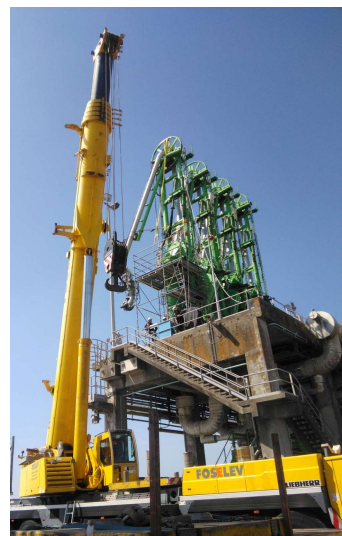
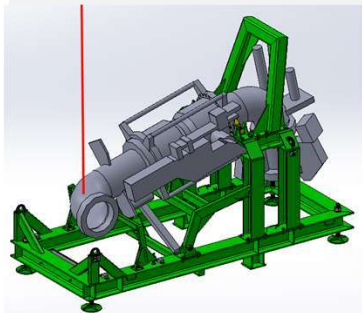

Z.A. Estuaire Sud – 4 Rue du Camp d'Aviation- 44320 Saint-Viaud

Tél. 02 40 39 67 40 - contact@armitec.fr - [www.armitec.fr](http://www.armitec.fr)

ENR-VTE-12-C